

- GRUNNMYND
- 1:1000

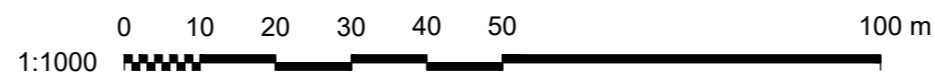

www.verkis.is - sími: 422 8000						
SAMPYKKT:						

A	2024-07-04	VERKTEIKNING	AKA	AKA	ÞRS	GJ
ÚTG	DAGS	SKÝRINGAR	TEIK	HANN	RÝNT	SAMP
VERKFANG	18117	TEIKNING	003.C71.O31	A		

Reykjavíkurborg Umhverfis- og skipulagssvið		Borgartún 12-14 105 Reykjavík Sími: 411 1111
GUFUNES 1. ÁFANGI GATNAGERÐ, YFIRBORDSFRÁGANGUR Yfirlitsmynd		
Mkv:	1:1000	Stærð: A2
Dags:	2024-07-04	Teikn. nr.: 031
		Útg.: A

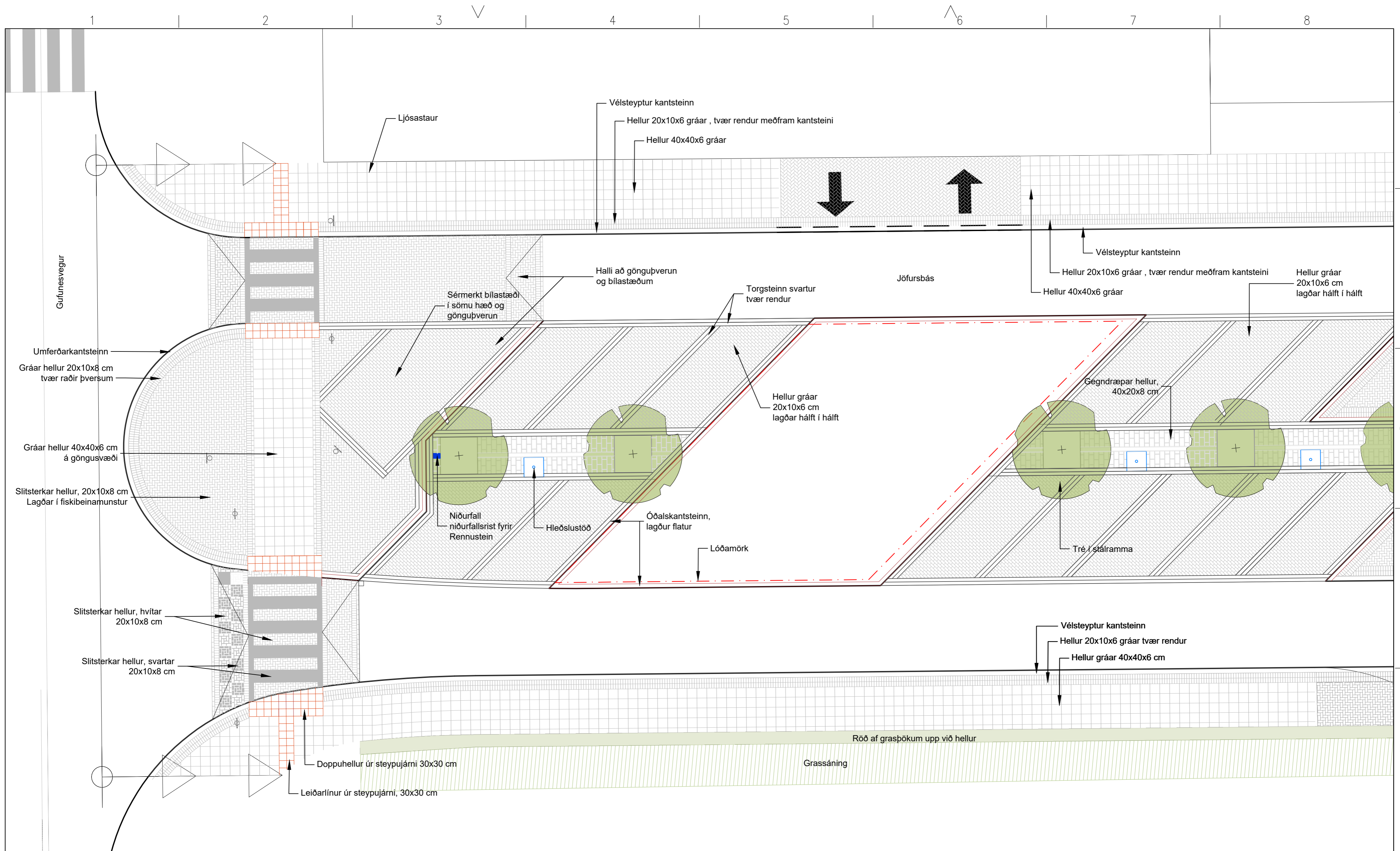

GRUNNMYND
1:100

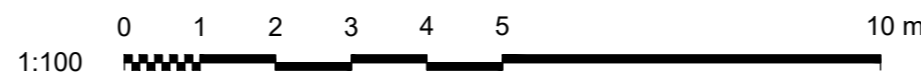

VERKÍS www.verkis.is - sími: 422 8000

SAMÞYKKT:

A	2024-07-04	VERKTEIKNING	AKA	AKA	ÞRS	GJ
ÚTG	DAGS	SKÝRINGAR	TEIK	HANN	RÝNT	SAMP
VERKFANG	18117	TEIKNING	003.C71.O32	A		

Reykjavíkurborg
Umhverfis- og skipulagssvið

Borgartún 12-14
105 Reykjavík
Sími: 411 1111

GUFUNES 1. ÁFANGI
GATNAGERÐ, YFIRBORDSFRÁGANGUR
Göngupverun, ofanvatnsrás, bílastæði

Mkv: 1:100	Stærð: A2	Teikn. nr.:	Útg.:
Dags: 2024-07-04		O32	A

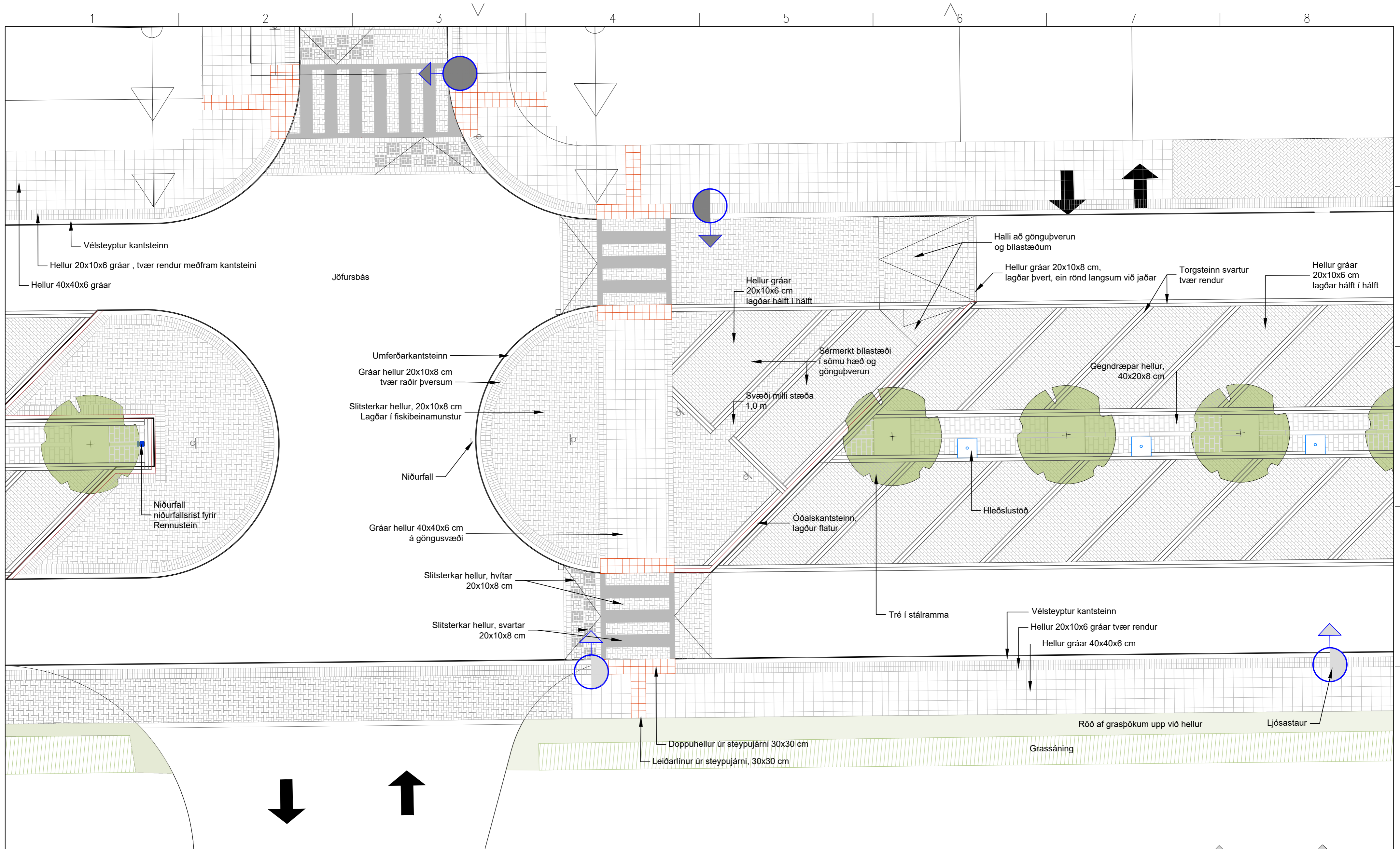

GRUNNMYND
1:100

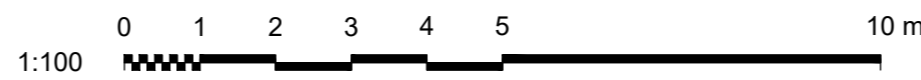

VERKÍS www.verkis.is - sími: 422 8000

SAMÞYKKT:

A	2024-07-04	VERKTEIKNING	AKA	AKA	ÞRS	GJ
ÚTG	DAGS	SKÝRINGAR	TEIK	HANN	RÝNT	SAMP
VERKFANG	18117	TEIKNING	003.C71.O33	A		

Reykjavíkurborg
Umhverfis- og skipulagssvið

Borgartún 12-14
105 Reykjavík
Sími: 411 1111

GUFUNES 1. ÁFANGI
GATNAGERÐ, YFIRBORDSFRÁGANGUR
Gönguþverun, ofanvatnsrás, bílastæði

Mkv:	1:100	Stærð:	A2	Teikn. nr.:	Útg.:
Dags:	2024-07-04			O33	A

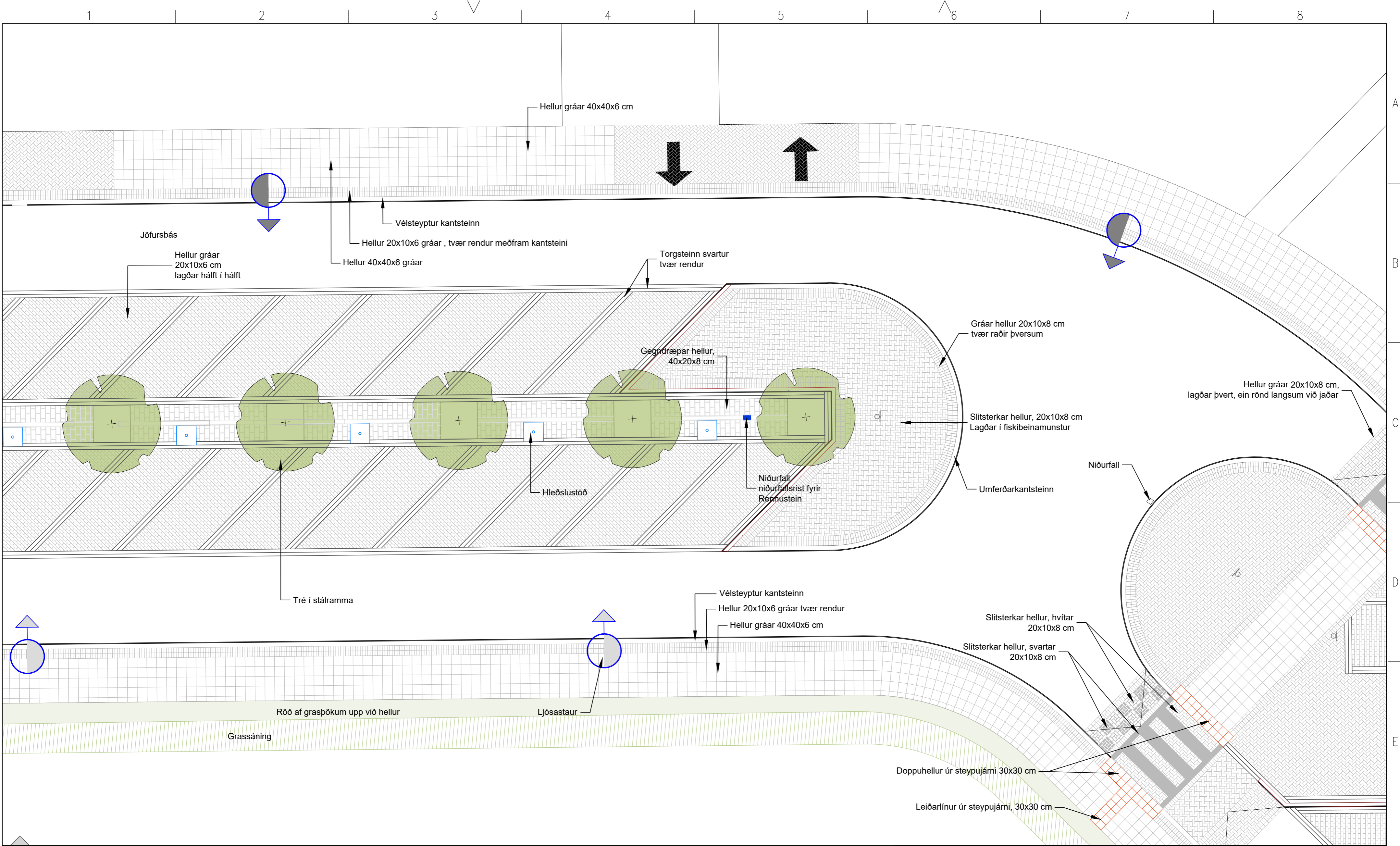

GRUNNMYND
1:100

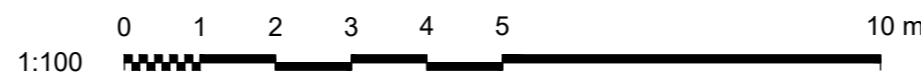

VERKÍS www.verkis.is - sími: 422 8000

Reykjavíkurborg
Umhverfis- og skipulagssvið
Borgartún 12-14
105 Reykjavík
Sími: 411 1111

SAMÞYKKT:

A	2024-07-04	VERKTEIKNING	AKA	AKA	ÞRS	GJ
ÚTG	DAGS	SKÝRINGAR	TEIK	HANN	RÝNT	SAMP
VERKFANG	18117	TEIKNING	003.C71.034	A		

GUFUNES 1. ÁFANGI
GATNAGERÐ, YFIRBORDSFRÁGANGUR
Gönguþverun, ofanvatnsrás, bílastæði

Mkv: 1:100	Stærð: A2	Teikn. nr.: O34	Útg.: A
Dags: 2024-07-04			

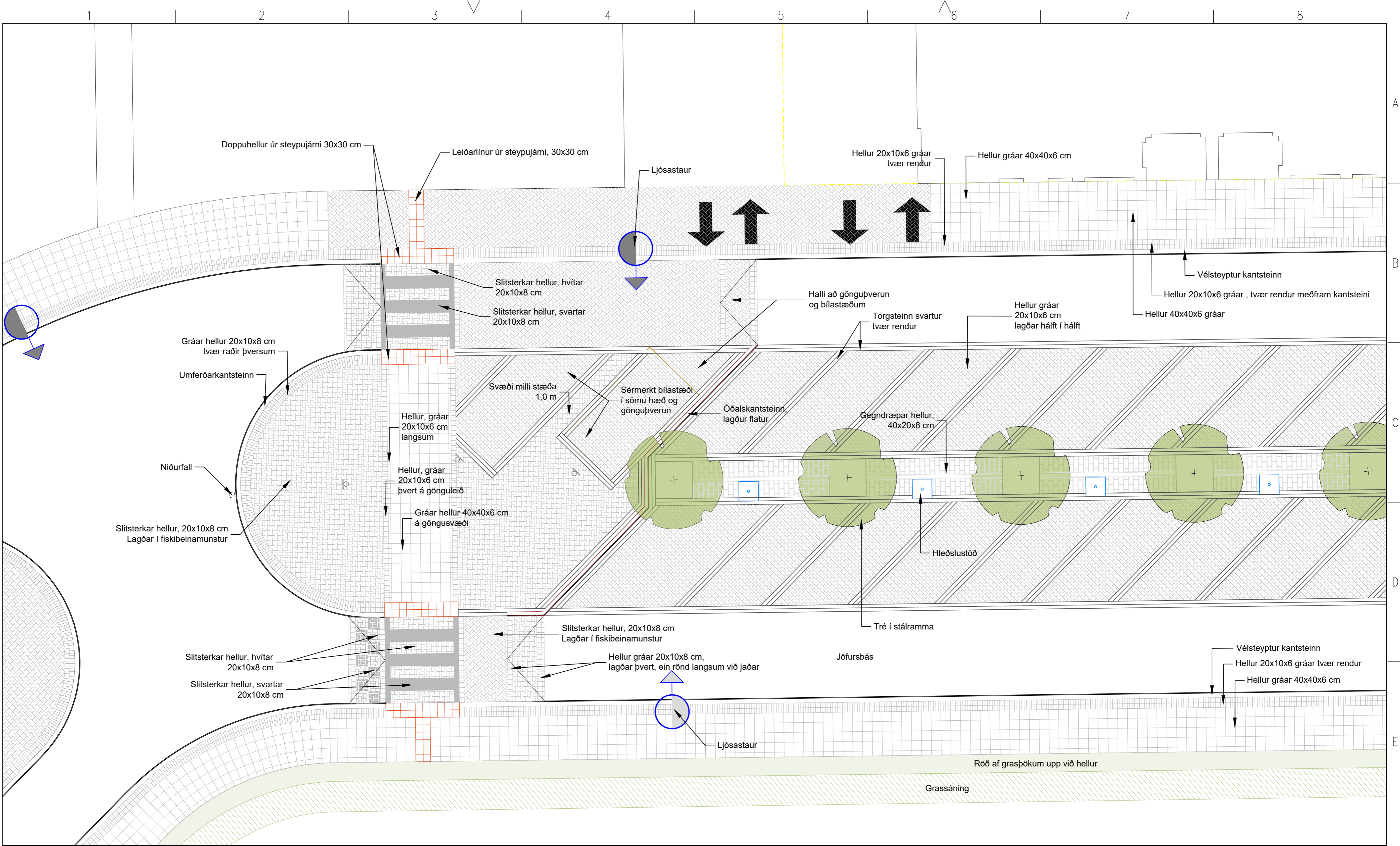

- GRUNNMYND
- 1:100

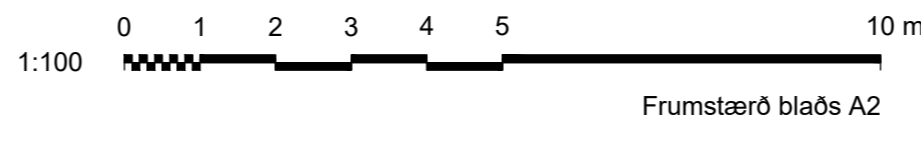

VERKÍS www.verkis.is - sími: 422 8000

SAMÞYKKT:

A	2024-07-04	VERKTEIKNING	AKA	AKA	ÞRS	GJ
ÚTG	DAGS	SKÝRINGAR	TEIK	HANN	RÝNT	SAMP
VERKFANG	18117	TEIKNING	003.C71.O35	A		

Reykjavíkurborg
Umhverfis- og skipulagssvið

Borgartún 12-14
105 Reykjavík
Sími: 411 1111

GUFUNES 1. ÁFANGI
GATNAGERÐ, YFIRBORDSFRÁGANGUR
Gönguþverun, ofanvatnsrás, bílastæði

Mkv:	1:100	Stærð:	A2	Teikn. nr.:	Útg.:
Dags:	2024-07-04			O35	A

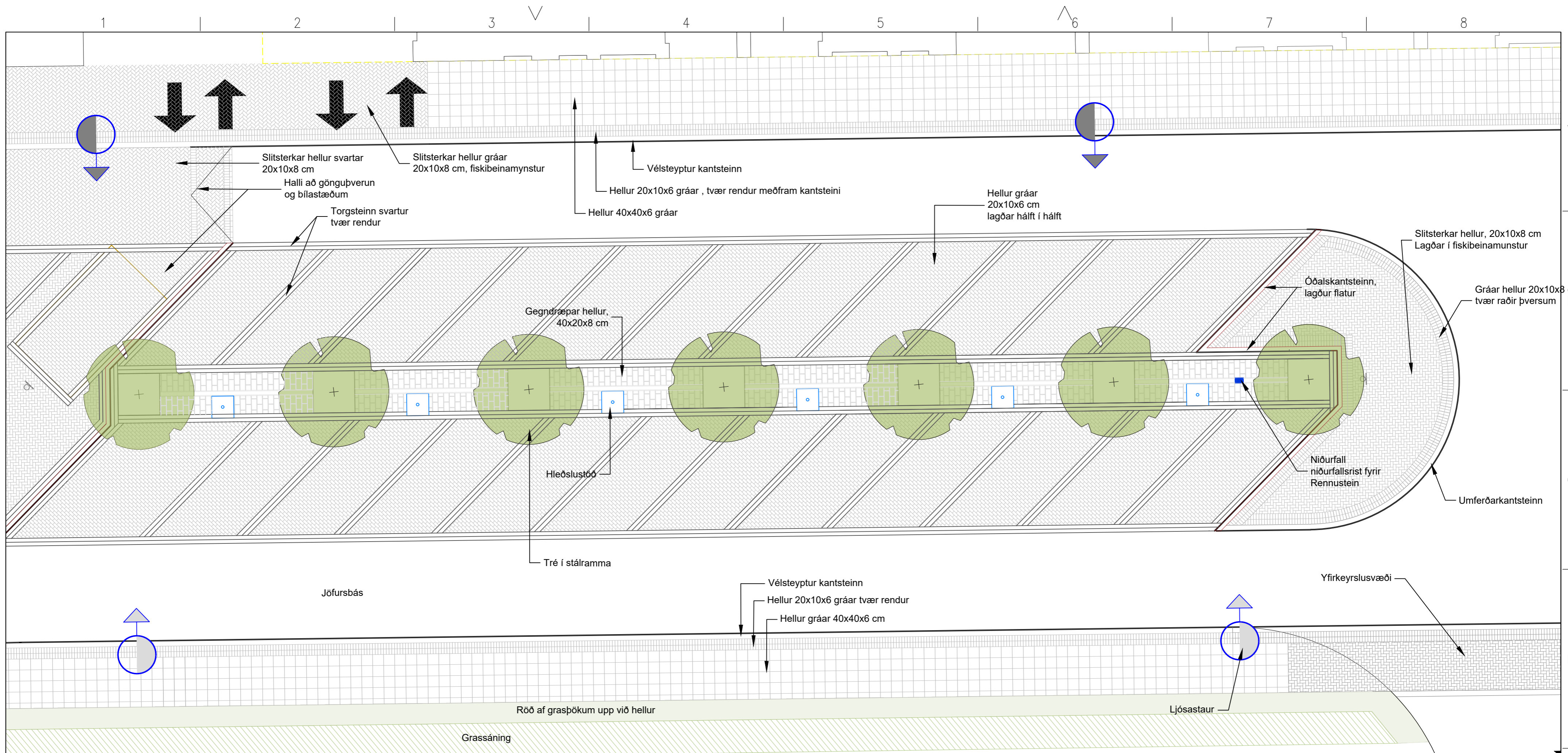

- GRUNNMYND
- 1:100

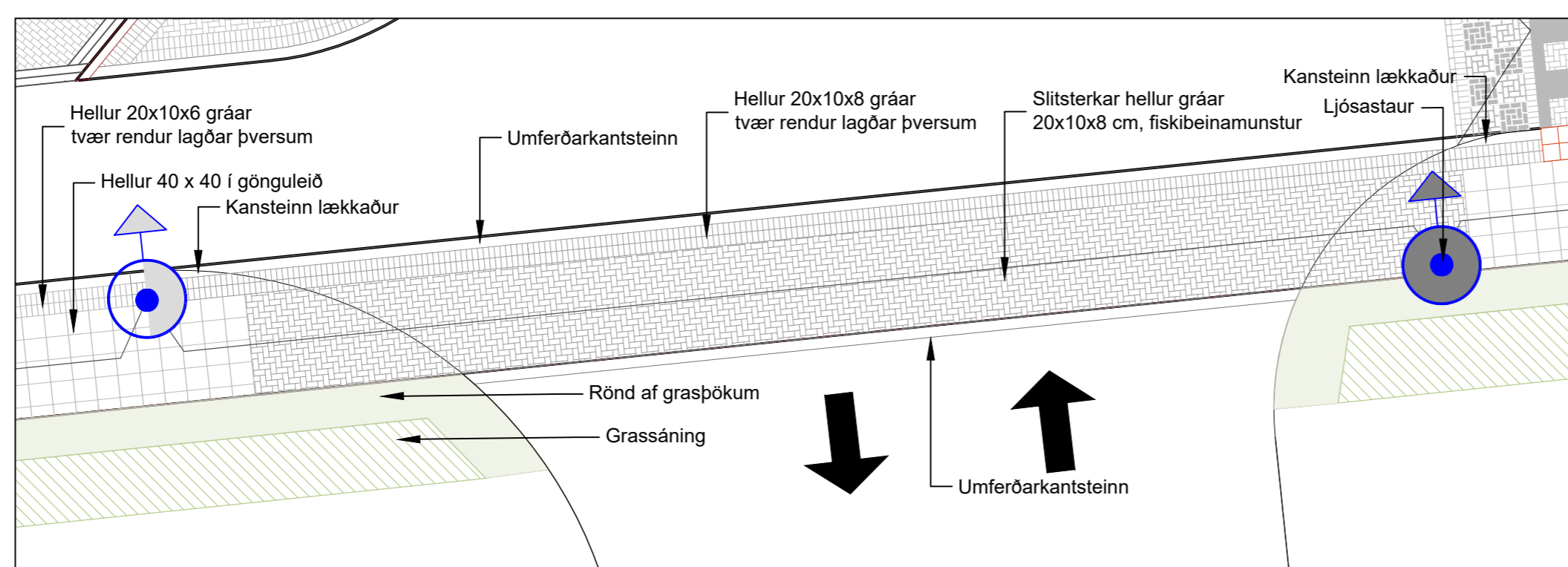

- GRUNNMYND - SÉRTEIKNING AF HELLULÖGN Á YFIRKEYRSLUSVÆÐI
- 1:100

0 1 2 3 4 5 10 m

Frumstærð blaðs A2

www.verkis.is - sími: 422 8000		Reykjavíkurborg Umhverfis- og skipulagssvið		Borgartún 12-14 105 Reykjavík Sími: 411 1111		
SAMPYKKT:		GUFUNES 1. ÁFANGI GATNAGERÐ, YFIRBORDSFRÁGANGUR Ofanvatnsrás, bílastæði og sérteikning yfirkeyrslusv.				
A	2024-07-04	VERKTEIKNING	AKA	AKA	ÞRS	GJ
ÚTG	DAGS	SKÝRINGAR	TEIK	HANN	RÝNT	SAMP
VERKFANG	18117	TEIKNING	003.C71.036	A	Mkv:	1:100
Dags: 2024-07-04		Stærð: A2	Teikn. nr.:	Útg.:	O36 A	

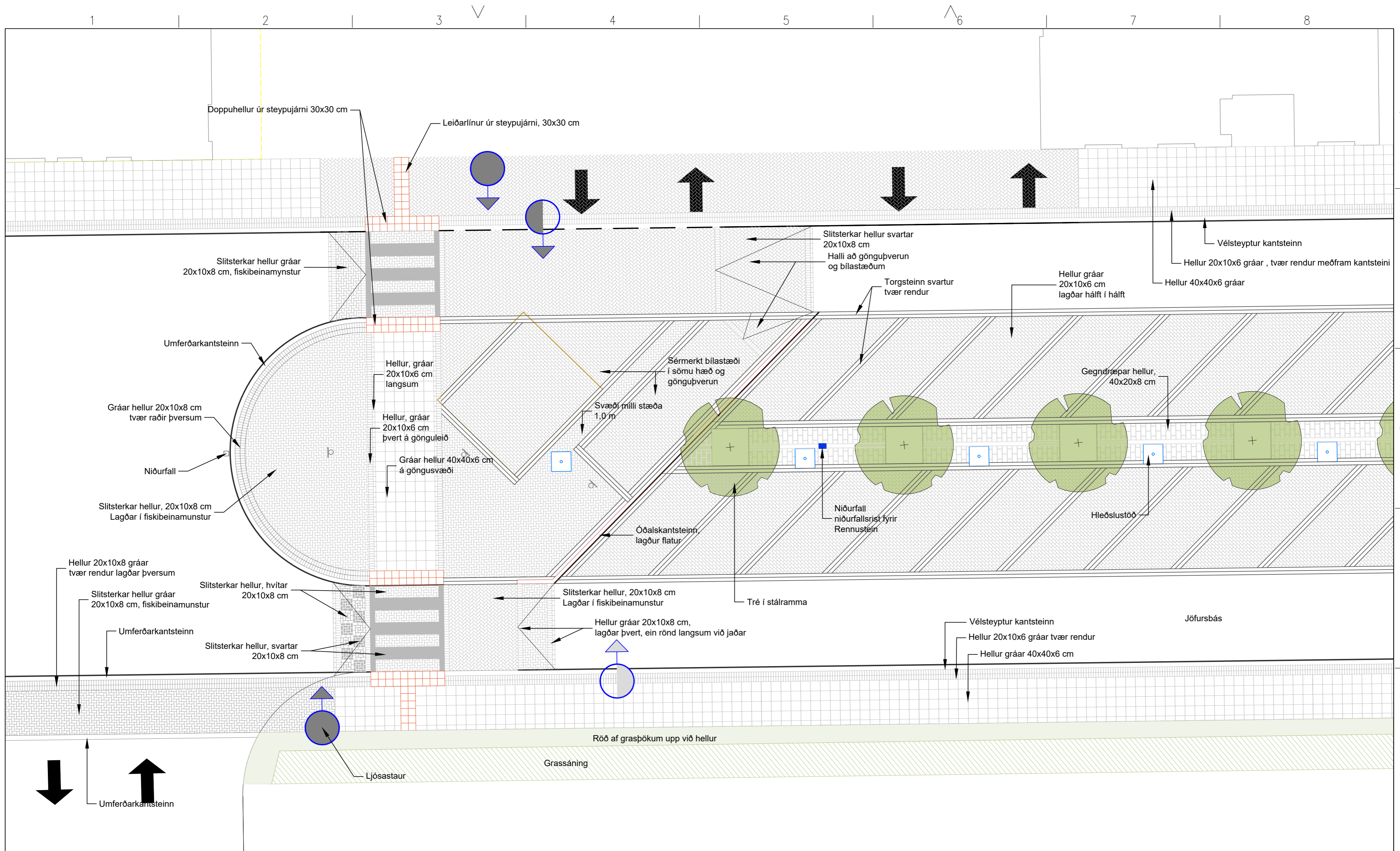

GRUNNMYND
1:100

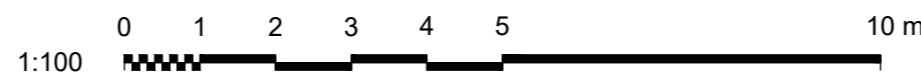

Frumstærð blaðs A2

VERKÍS www.verkis.is - sími: 422 8000

SAMÞYKKT:

A	2024-07-04	VERKTEIKNING	AKA	AKA	ÞRS	GJ
ÚTG	DAGS	SKÝRINGAR	TEIKNING	HANN	RÝNT	SAMP
VERKFANG	18117	TEIKNING	003.C71.037	A		

Reykjavíkurborg
Umhverfis- og skipulagssvið

Borgartún 12-14
105 Reykjavík
Sími: 411 1111

GUFUNES 1. ÁFANGI
GATNAGERÐ, YFIRBORDSFRÁGANGUR
Gönguþverun, ofanvatnsrás, bílastæði

Mkv:	1:100	Stærð:	A2	Teikn. nr.:	Útg.:
Dags:	2024-07-04			O37	A

© Öll athot og afritun teikningar, að hluta eða í heild er háð skriflegu leyfi höfundar

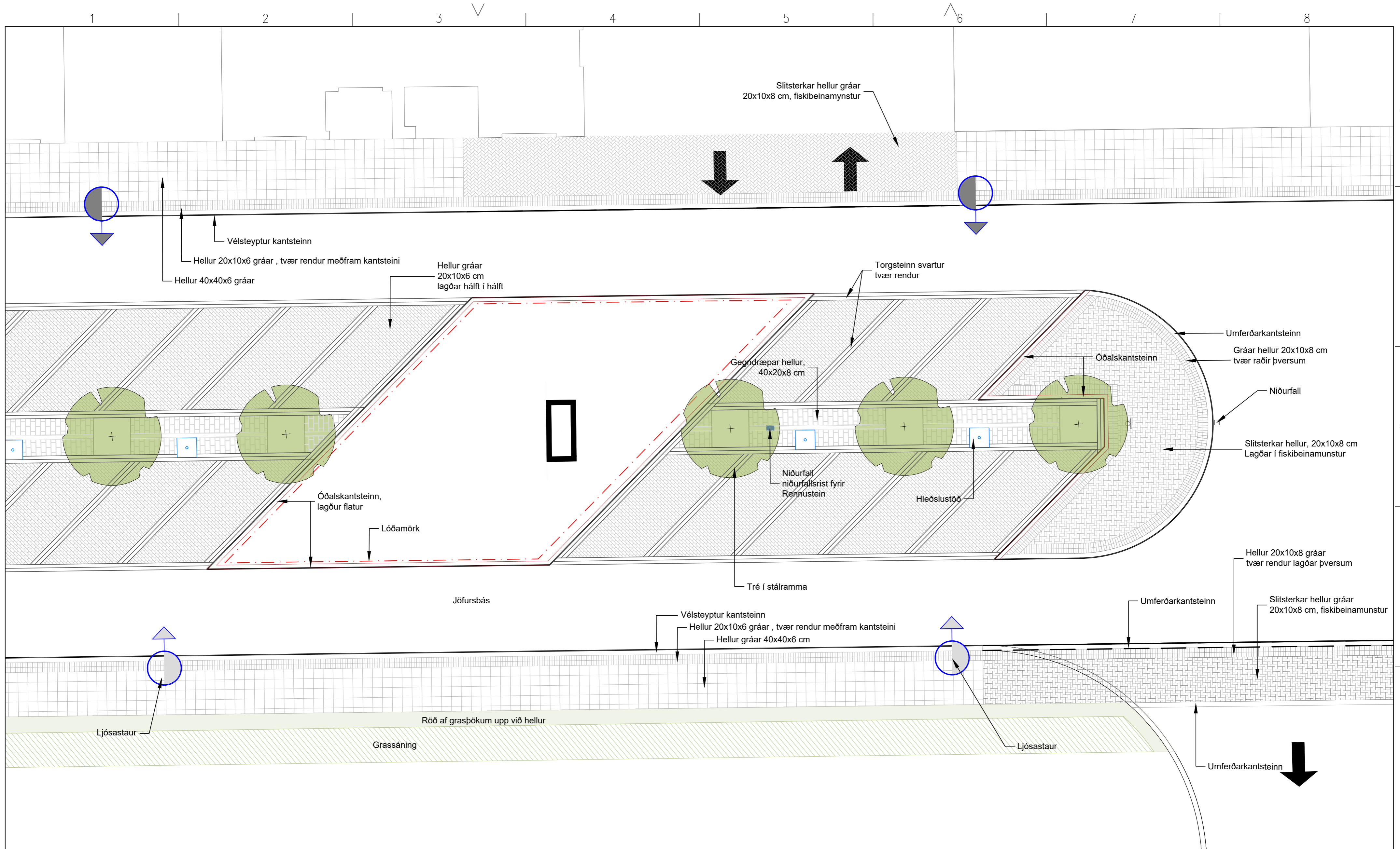

GRUNNMYND
1:100

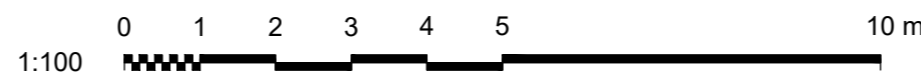

Frumstærð blaðs A2

VERKÍS www.verkis.is - sími: 422 8000

SAMÞYKKT:

A	2024-07-04	VERKTEIKNING	AKA	AKA	ÞRS	GJ
ÚTG	DAGS	SKÝRINGAR	TEIK	HANN	RÝNT	SAMP
VERKFANG	18117	TEIKNING	003.C71.038	A		

Reykjavíkurborg
Umhverfis- og skipulagssvið

Borgartún 12-14
105 Reykjavík
Sími: 411 1111

GUFUNES 1. ÁFANGI
GATNAGERÐ, YFIRBORDSFRÁGANGUR
Ofanvatnsrás, bílastæði

Mkv: 1:100	Stærð: A2	Teikn. nr.: O38	Útg.: A
Dags: 2024-07-04			

© Öll athot og afritun teikningar, að hluta eða í heild er háð skriflegu leyfi höfundar

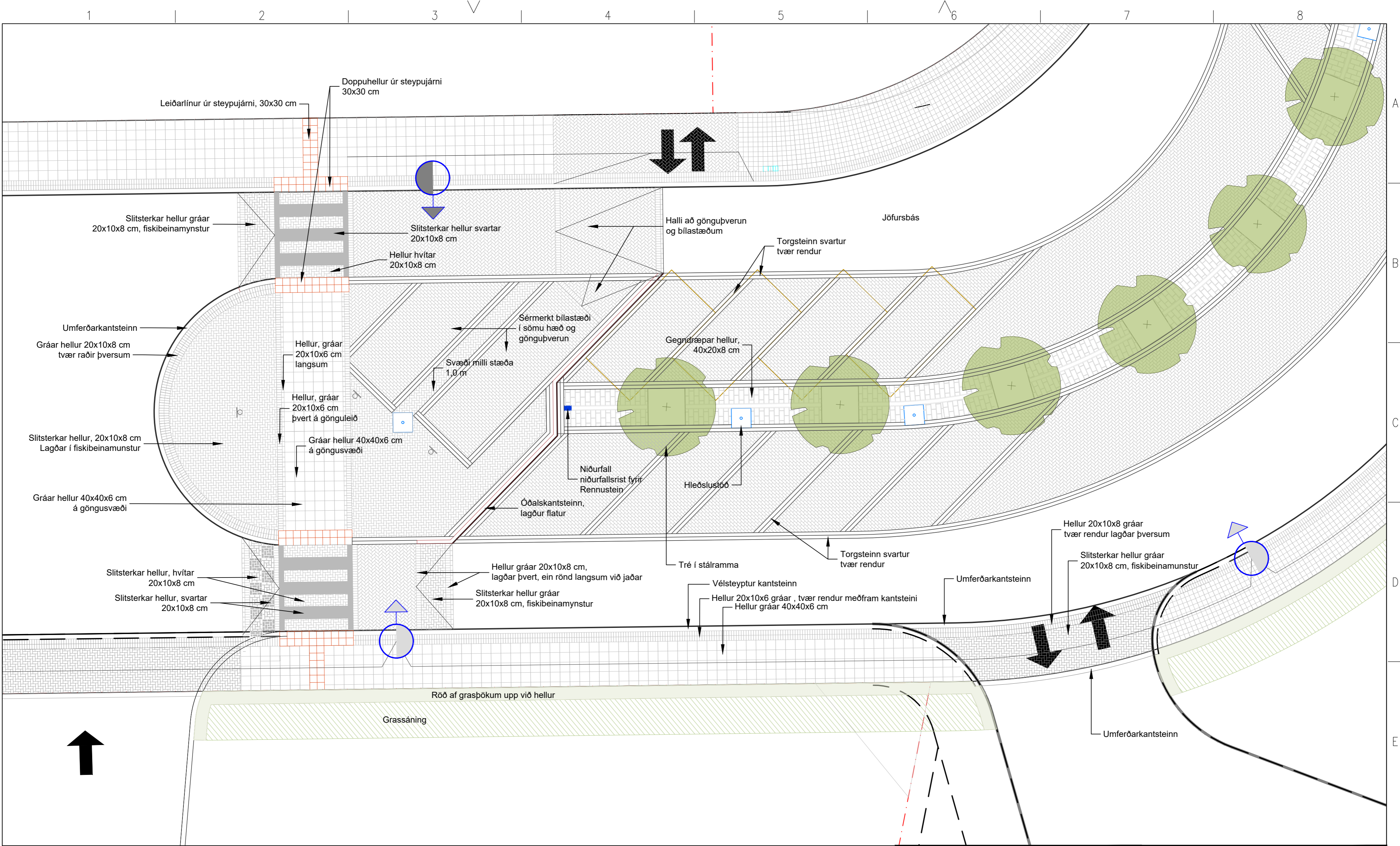

GRUNNMYND
1:100

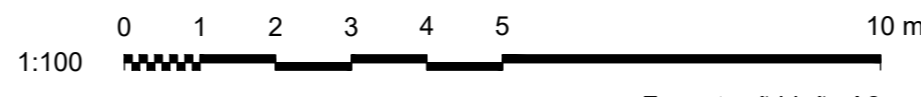

Frumstærð blaðs A2

VERKÍS www.verkis.is - sími: 422 8000

SAMÞYKKT:

A	2024-07-04	VERKTEIKNING	AKA	AKA	ÞRS	GJ
ÚTG	DAGS	SKÝRINGAR	TEIK	HANN	RYNT	SAMP
VERKFANG	18117	TEIKNING	003.C71.O39	A		

Reykjavíkurborg
Umhverfis- og skipulagssvið

Borgartún 12-14
105 Reykjavík
Sími: 411 1111

GUFUNES 1. ÁFANGI
GATNAGERÐ, YFIRBORDSFRÁGANGUR
Gönguþverun, ofanvatnsrás, bílastæði

Mkv:	1:100	Stærð:	A2	Teikn. nr.:	Útg.:
Dags:	2024-07-04			O39	A

© Öll athot og afritun teikningar, að hluta eða í heild er háð skriflegu leyfi höfundar

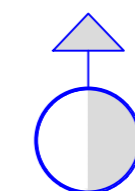
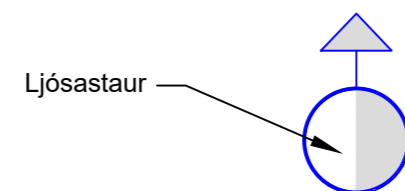
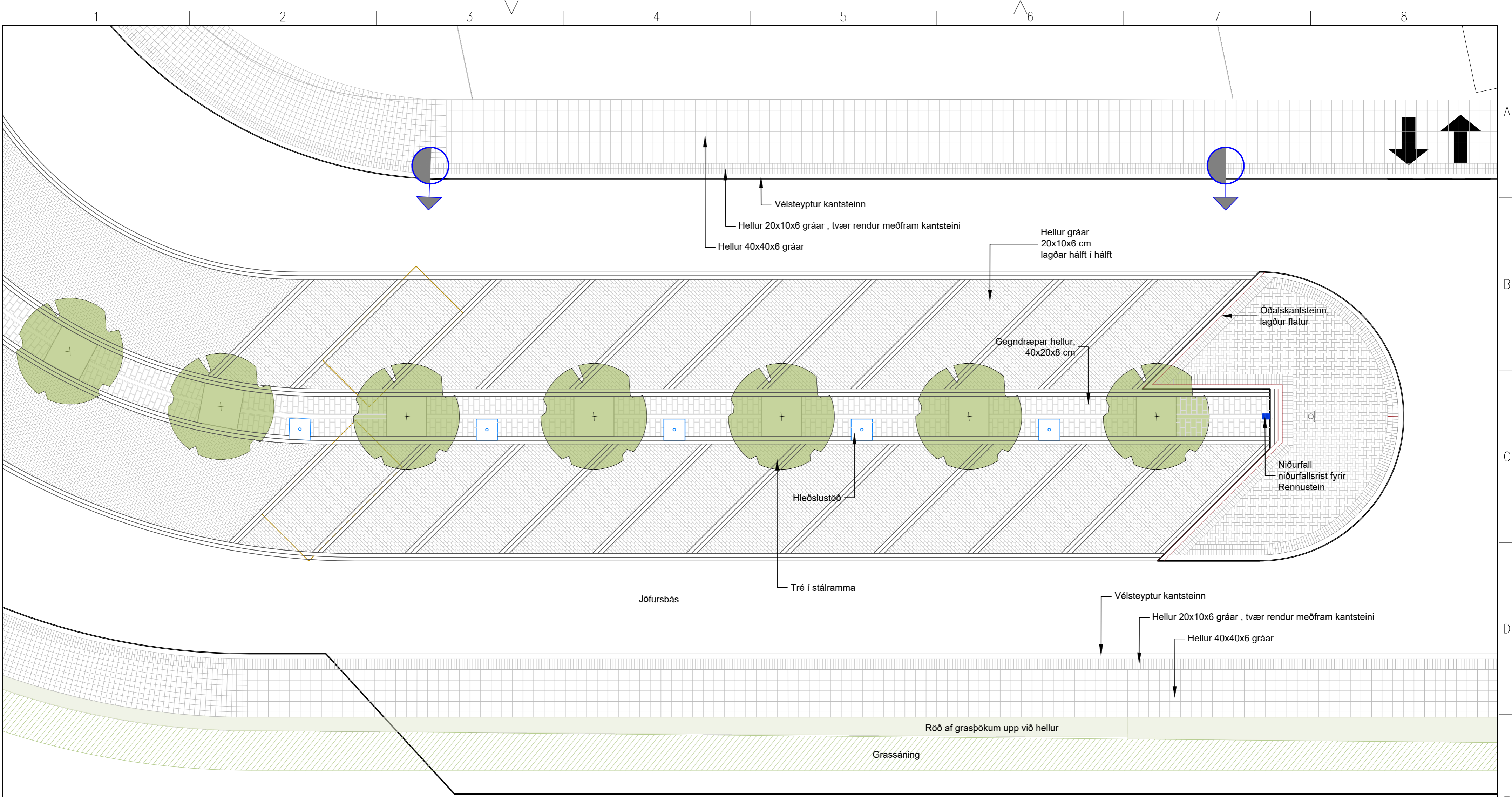

GRUNNMYND
1:100

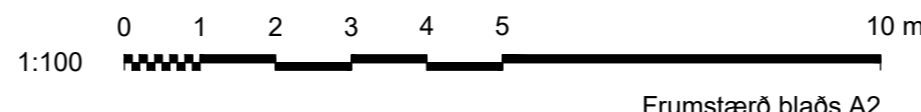

VERKÍS www.verkis.is - sími: 422 8000

SAMÞYKKT:

A	2024-07-04	VERKTEIKNING	AKA	AKA	ÞRS	GJ
ÚTG	DAGS	SKÝRINGAR	TEIK	HANN	RÝNT	SAMP
VERKFANG	18117	TEIKNING	003.C71.040	A		

Reykjavíkurborg
Umhverfis- og skipulagssvið
Borgartún 12-14
105 Reykjavík
Sími: 411 1111

GUFUNES 1. ÁFANGI
GATNAGERÐ, YFIRBORDSFRÁGANGUR
Gönguþverun, ofanvatnsrás, bílastæði

Mkv:	1:100	Stærð:	A2	Teikn. nr.:	Útg.:
Dags:	2024-07-04			O40	A

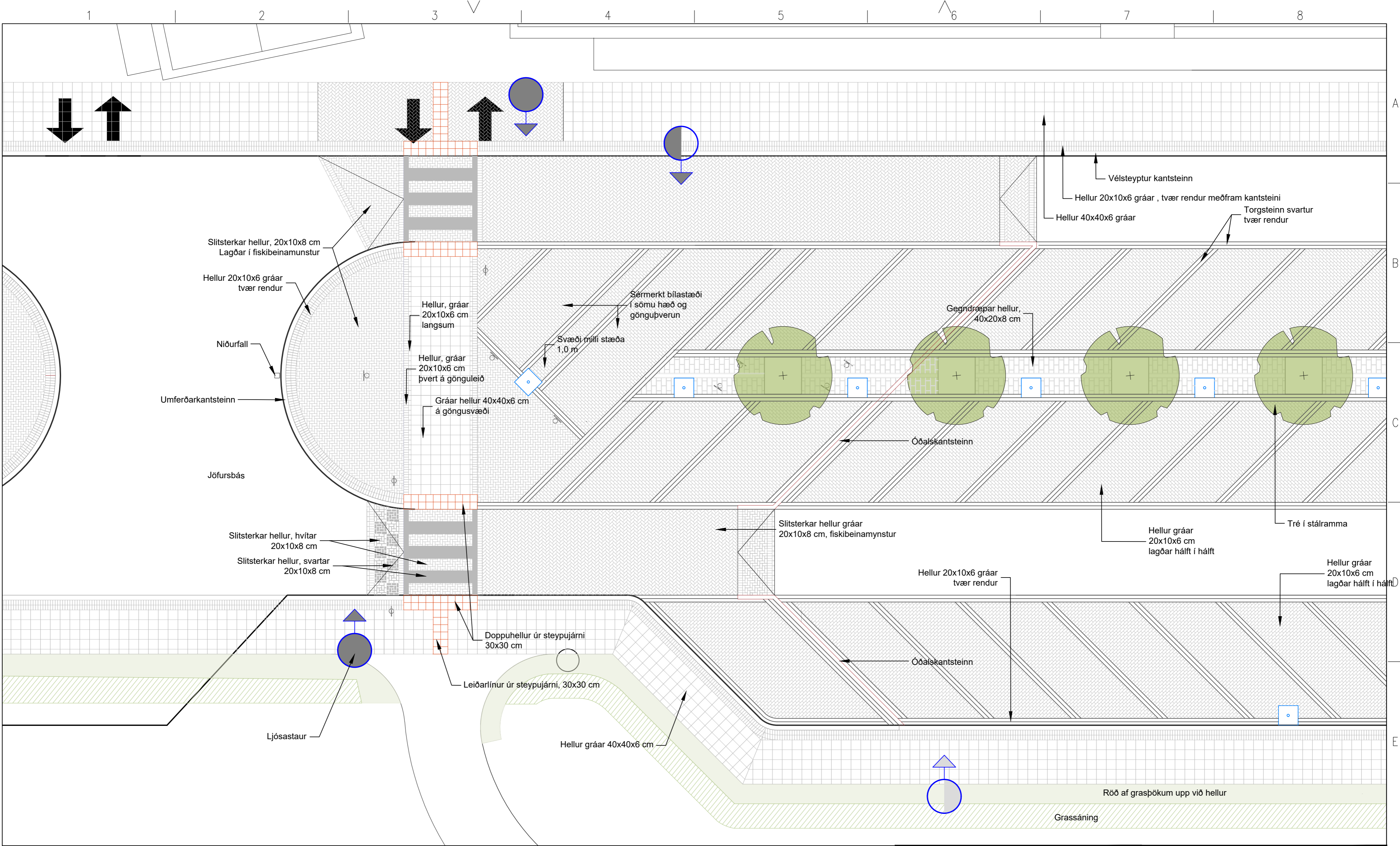

GRUNNMYND
1:100

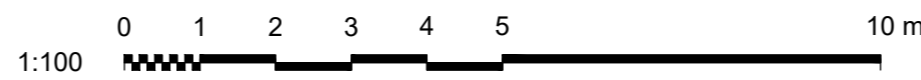

VERKÍS www.verkis.is - sími: 422 8000

Reykjavíkurborg
Umhverfis- og skipulagssvið
Borgartún 12-14
105 Reykjavík
Sími: 411 1111

SAMÞYKKT:

A	2024-07-04	VERKTEIKNING	AKA	AKA	ÞRS	GJ
ÚTG	DAGS	SKÝRINGAR	TEIK	HANN	RÝNT	SAMP
VERKFANG	18117	TEIKNING	003.C71.041	A		

GUFUNES 1. ÁFANGI
GATNAGERÐ, YFIRBORDSFRÁGANGUR
Gönguþverur, ofanvatnsrás, bílastæði

Mkv:	1:100	Stærð:	A2	Teikn. nr.:	Útg.:
Dags:	2024-07-04			O41	A

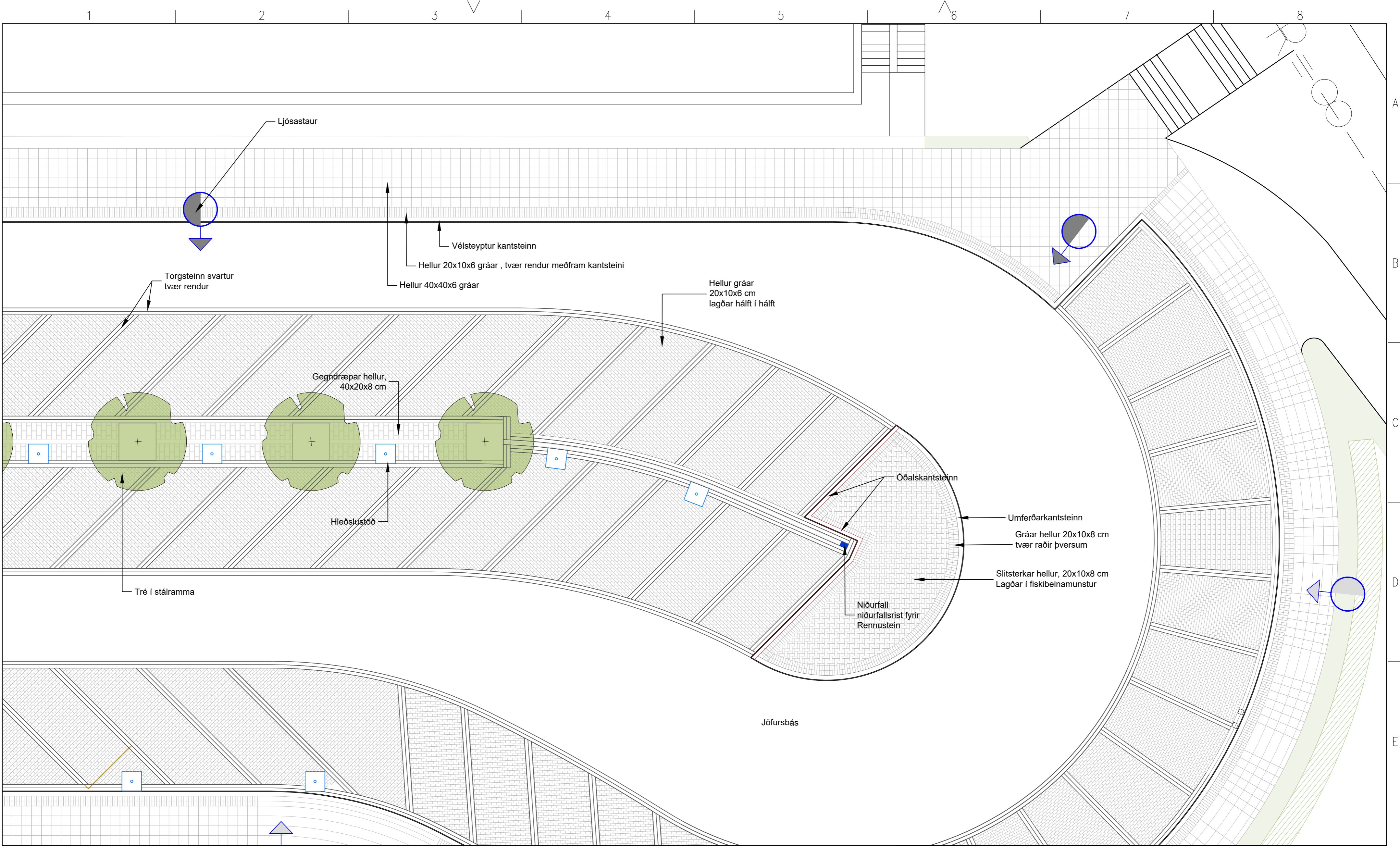

GRUNNMYND
1:100

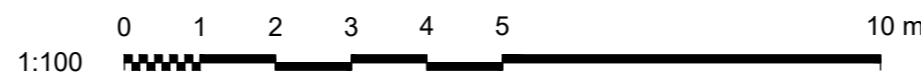

VERKÍS www.verkis.is - sími: 422 8000

SAMÞYKKT:

A	2024-07-04	VERKTEIKNING	AKA	AKA	ÞRS	GJ
ÚTG	DAGS	SKÝRINGAR	TEIK	HANN	RÝNT	SAMP
VERKFANG	18117	TEIKNING	003.C71.042	A		

Reykjavíkurborg
Umhverfis- og skipulagssvið

Borgartún 12-14
105 Reykjavík
Sími: 411 1111

GUFUNES 1. ÁFANGI
GATNAGERÐ, YFIRBORDSFRÁGANGUR
Gönguþverun, ofanvatnsrás, bílastæði

Mkv: 1:100	Stærð: A2	Teikn. nr.: O42	Útg.: A
Dags: 2024-07-04			

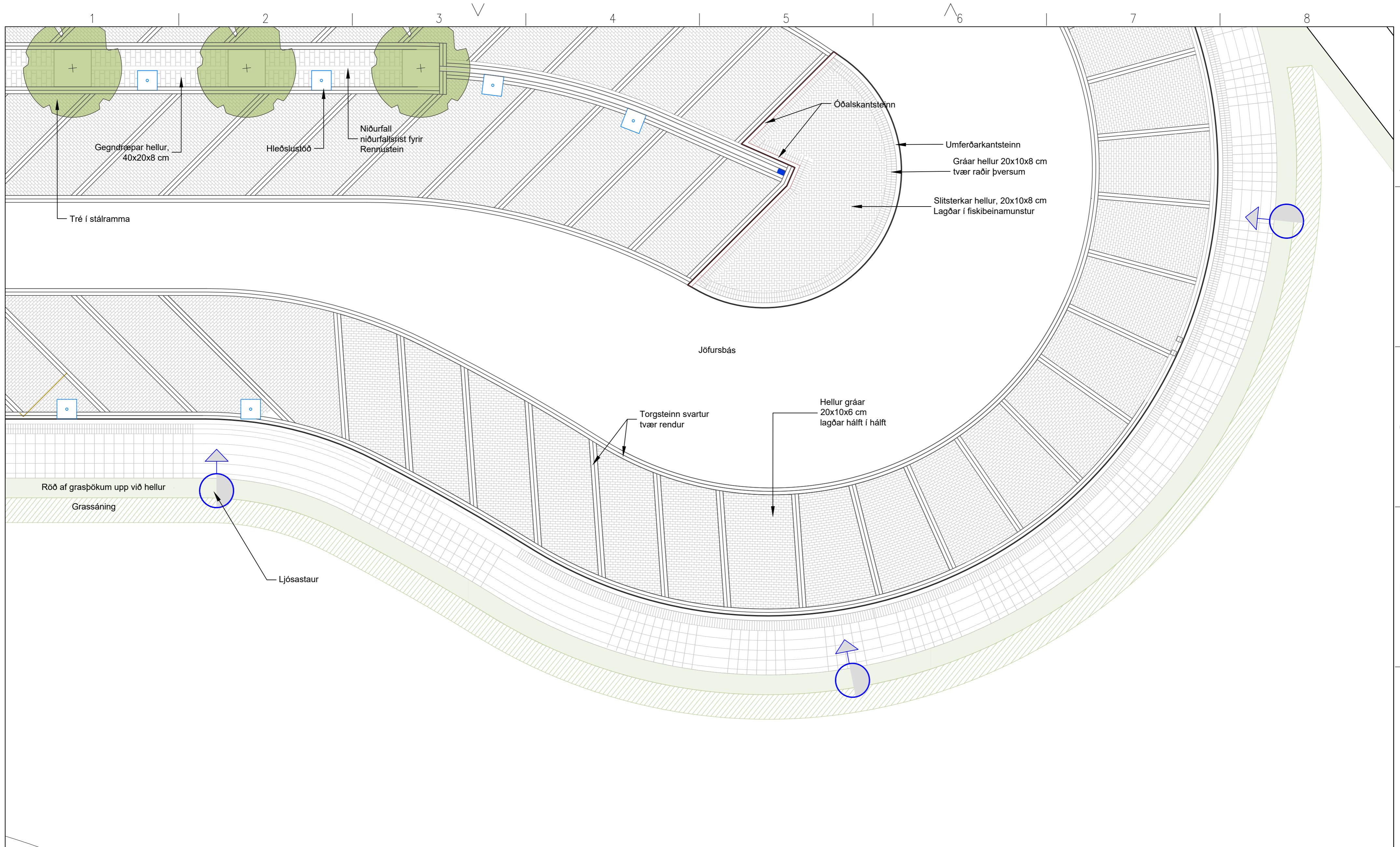

GRUNNMYND
1:100

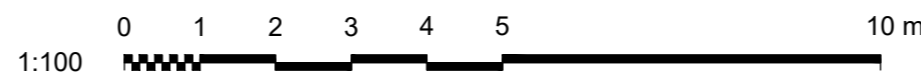

VERKÍS www.verkis.is - sími: 422 8000

SAMÞYKKT:

A	2024-07-04	VERKTEIKNING	AKA	AKA	ÞRS	GJ
ÚTG	DAGS	SKÝRINGAR	TEIK	HANN	RÝNT	SAMP
VERKFANG	18117	TEIKNING	003.C71.043	A		

Reykjavíkurborg
Umhverfis- og skipulagssvið

Borgartún 12-14
105 Reykjavík
Sími: 411 1111

GUFUNES 1. ÁFANGI
GATNAGERÐ, YFIRBORDSFRÁGANGUR
Gönguþverun, ofanvatnsrás, bílastæði

Mkv:	1:100	Stærð:	A2	Teikn. nr.:	Útg.:
Dags:	2024-07-04			O43	A

© Öll athot og afritun teikningar, að hluta eða í heild er háð skriflegu leyfi höfundar

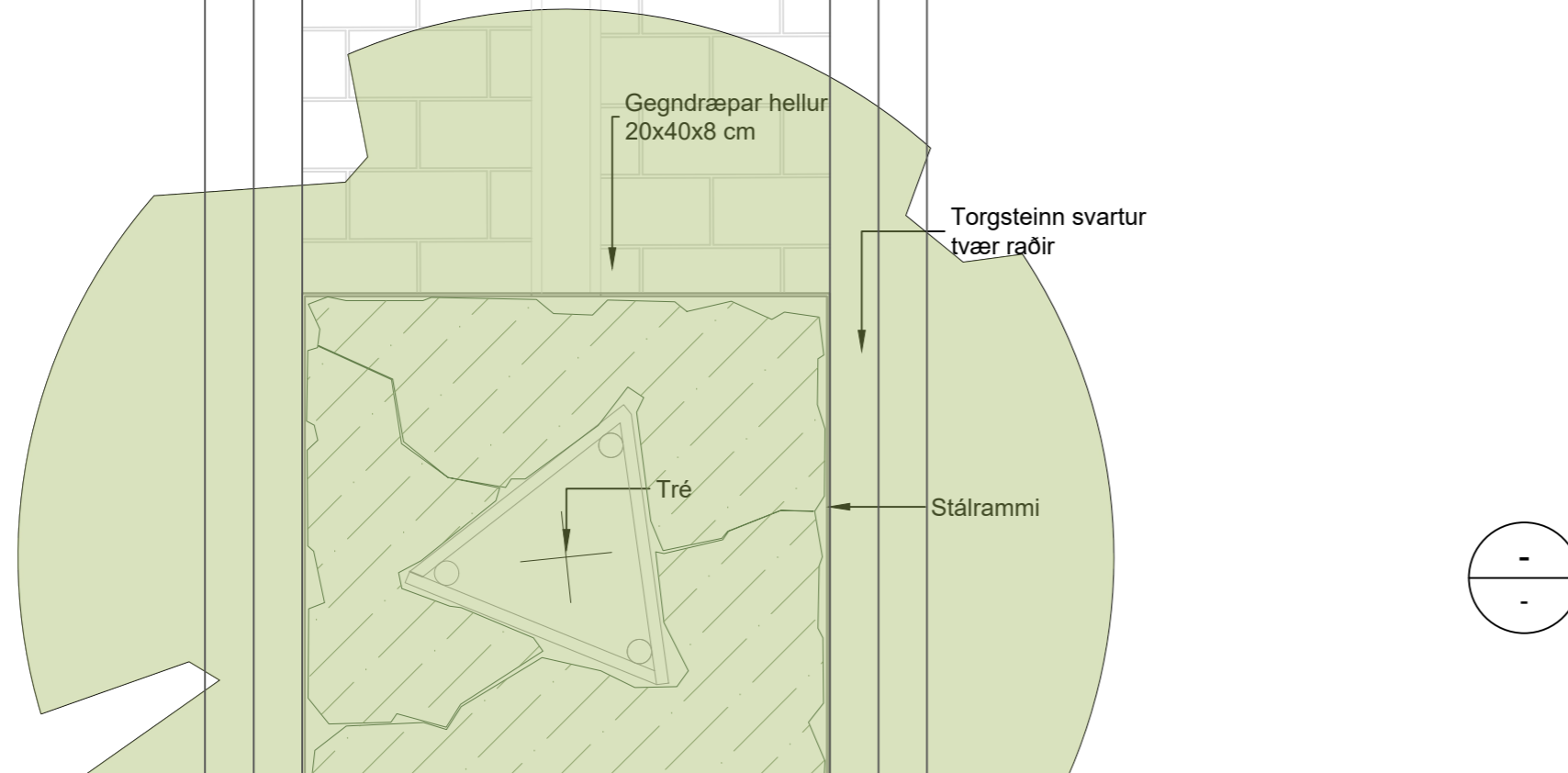

- GRUNNMYND - OFANVATNSRÁS
- 1:20

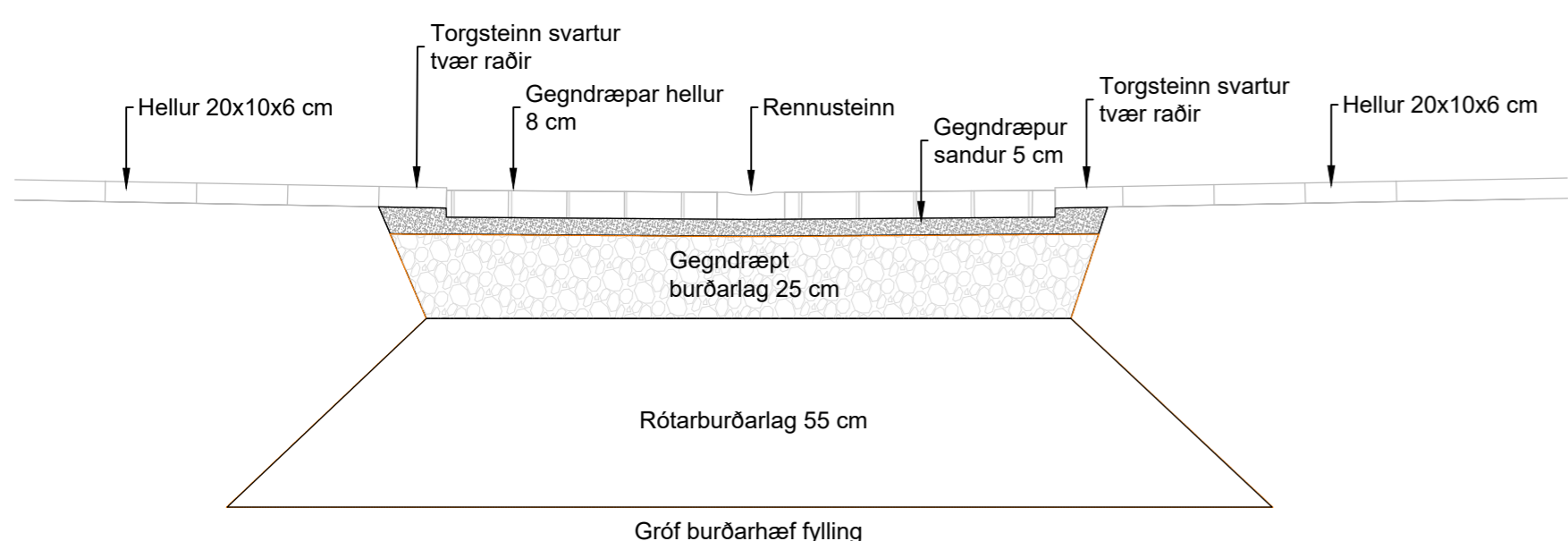

- SNIÐ Í GEGNDRÆPAR HELLUR Í OFANVATNSRÁS
- 1:20

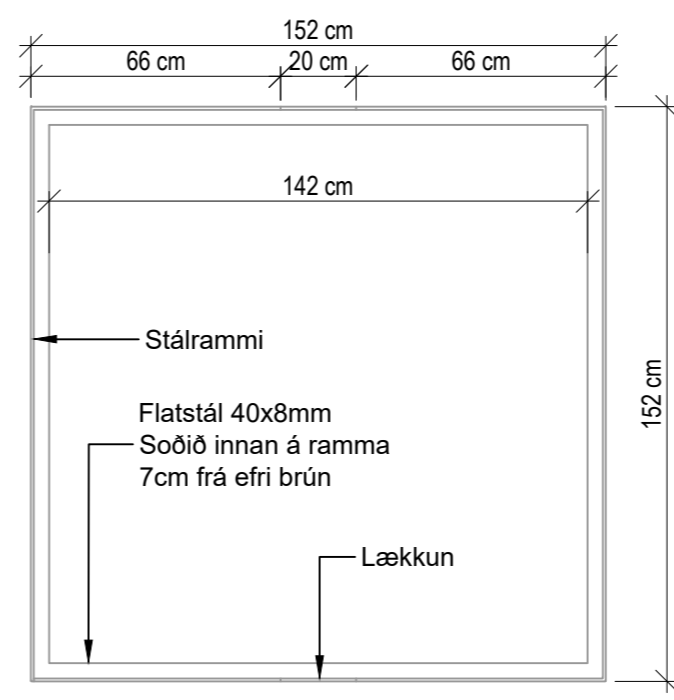

- STÁLRAMMI FYRIR STÖK GÖTUTRÉ
- 1:20

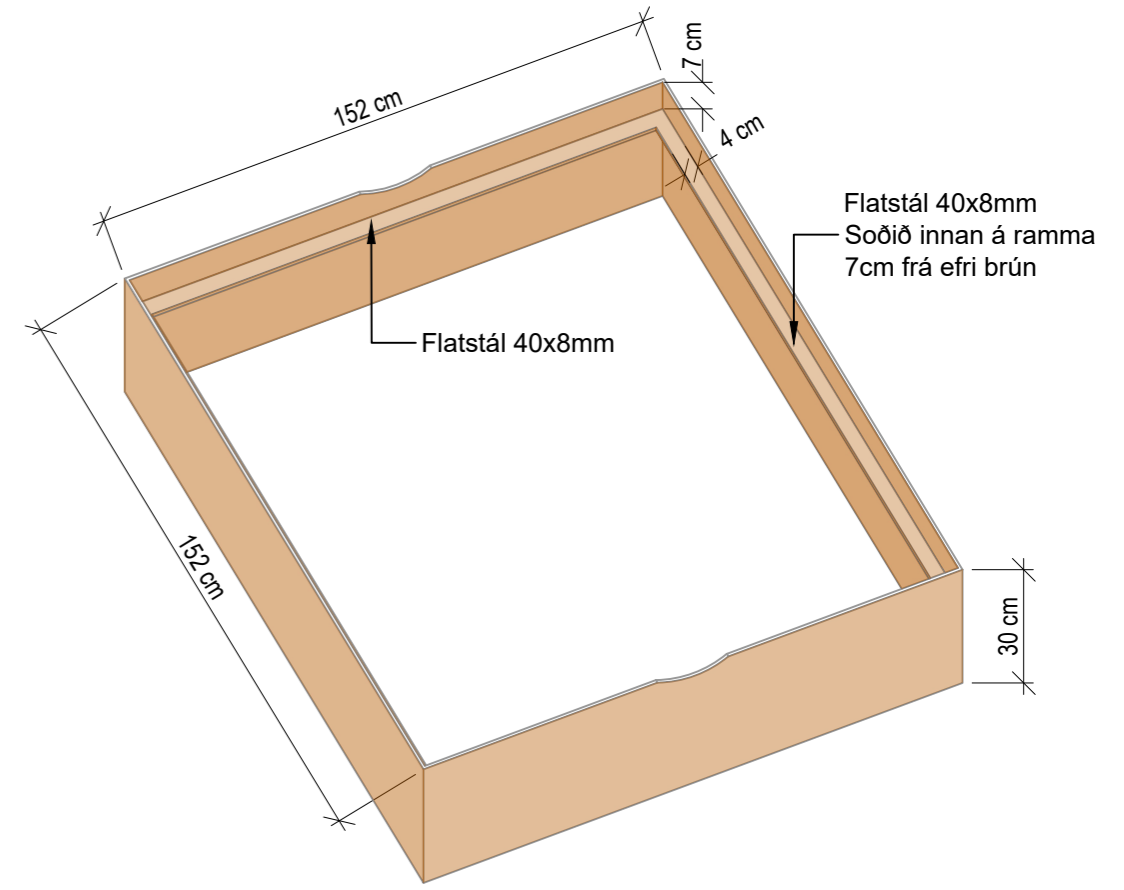

- STÁLRAMMI FYRIR STÖK GÖTUTRÉ
- 1:20

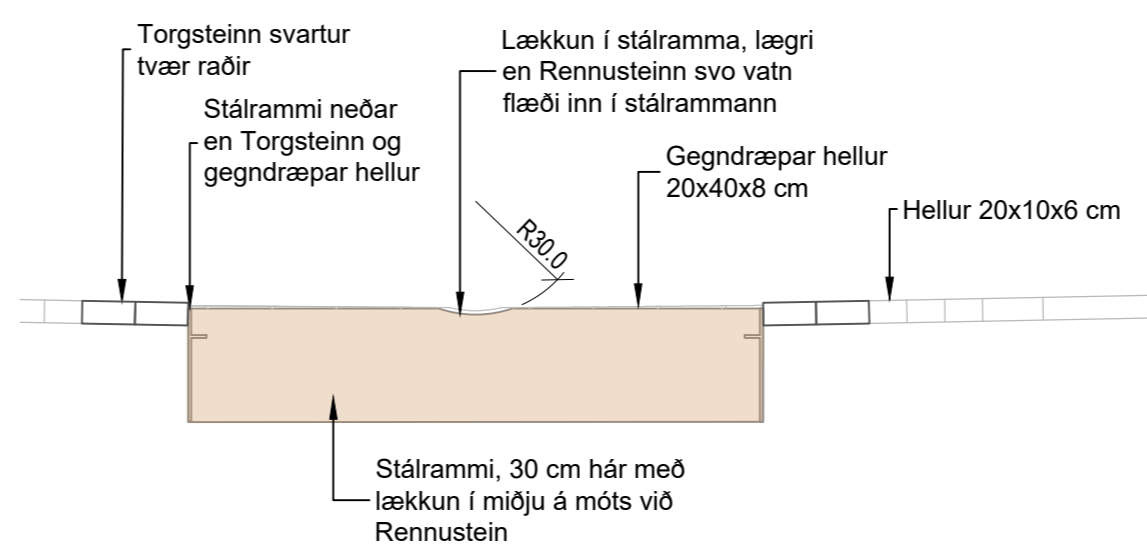

- SNIÐ - STÁLRAMMI Í OFANVATNSRÁS
- 1:20

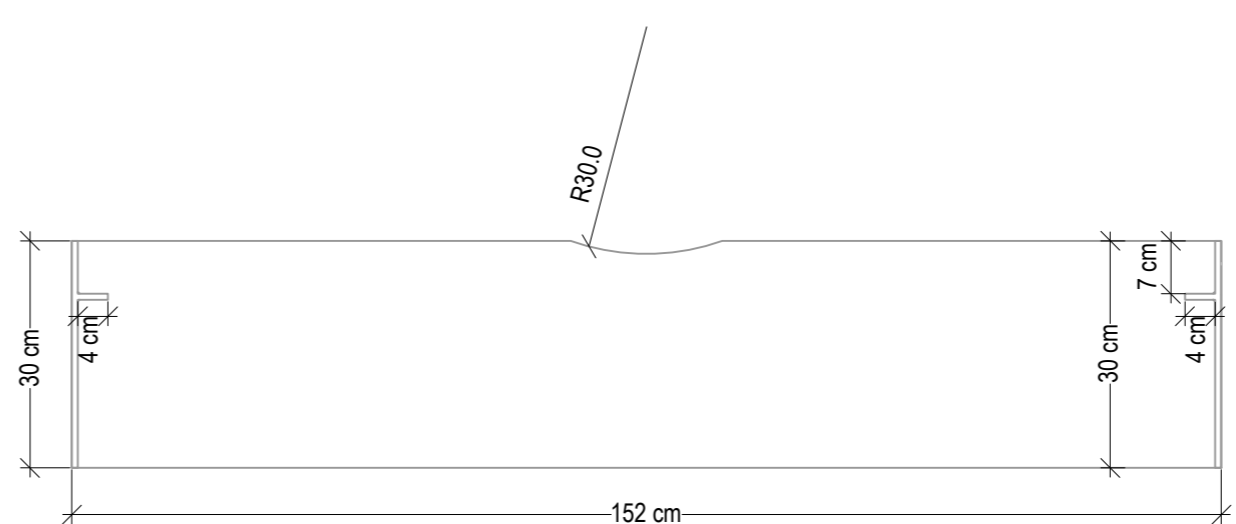

- SNIÐ - FLATSTÁL SOÐIÐ INNAN Á RAMMA
- 1:10

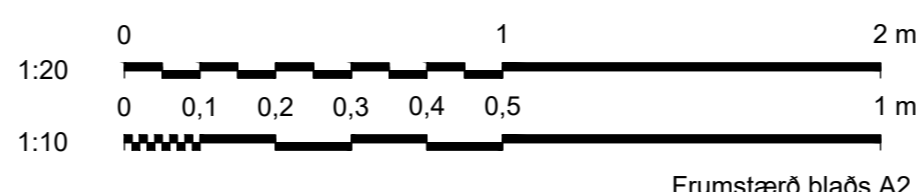

www.verkis.is - sími: 422 8000		Reykjavíkurborg Umhverfis- og skipulagssvið		Borgartún 12-14 105 Reykjavík Sími: 411 1111		
SAMPYKKT:		GUFUNES 1. ÁFANGI GATNAGERÐ, YFIRBORDSFRÁGANGUR Sérteikningar og snið - stálrammar, ofanvatnsrás				
A	2024-07-04	VERKTEIKNING	AKA	AKA	ÞRS	GJ
ÚTG	DAGS	SKÝRINGAR	TEIK	HANN	RÝNT	SAMP
VERKFANG	18117	TEIKNING	003.C71.046	A	Mkv:	1:20/1:10
Dags:		2024-07-04		Stærð:	A2	
				Teikn. nr.:	O46	
				Útg.:	A	

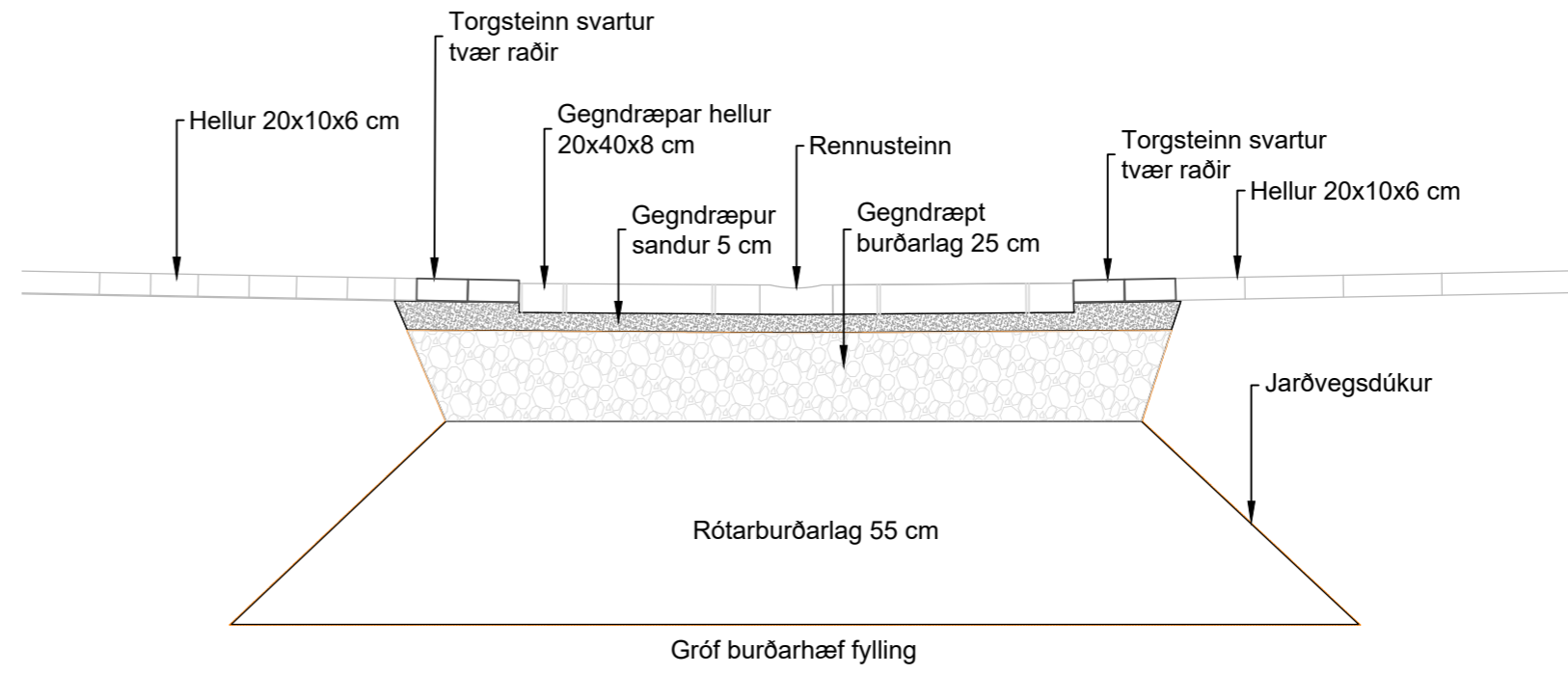
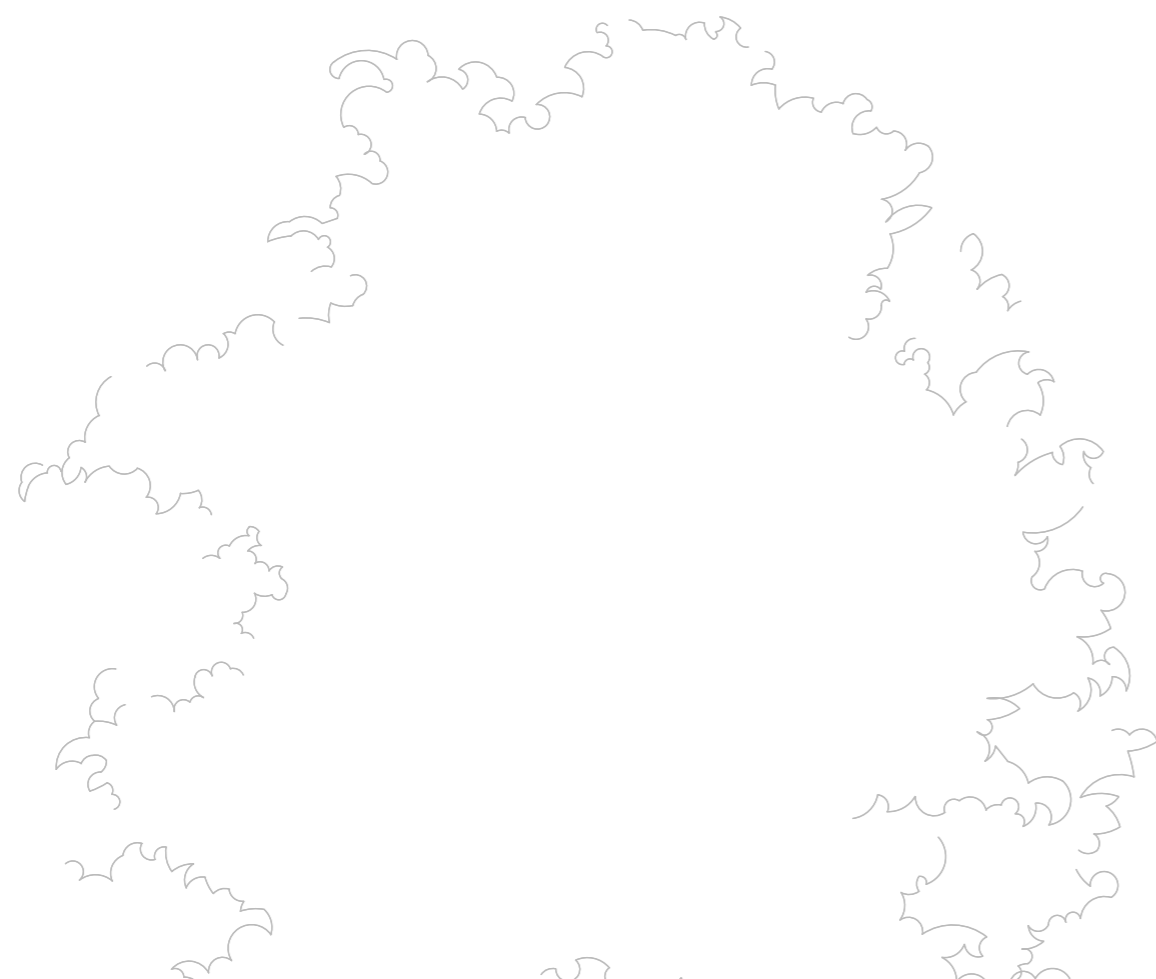

- SNIÐ - OFANVATNSRÁS, SVÆÐI MILLI TRJÁRAMMA
- 1:20

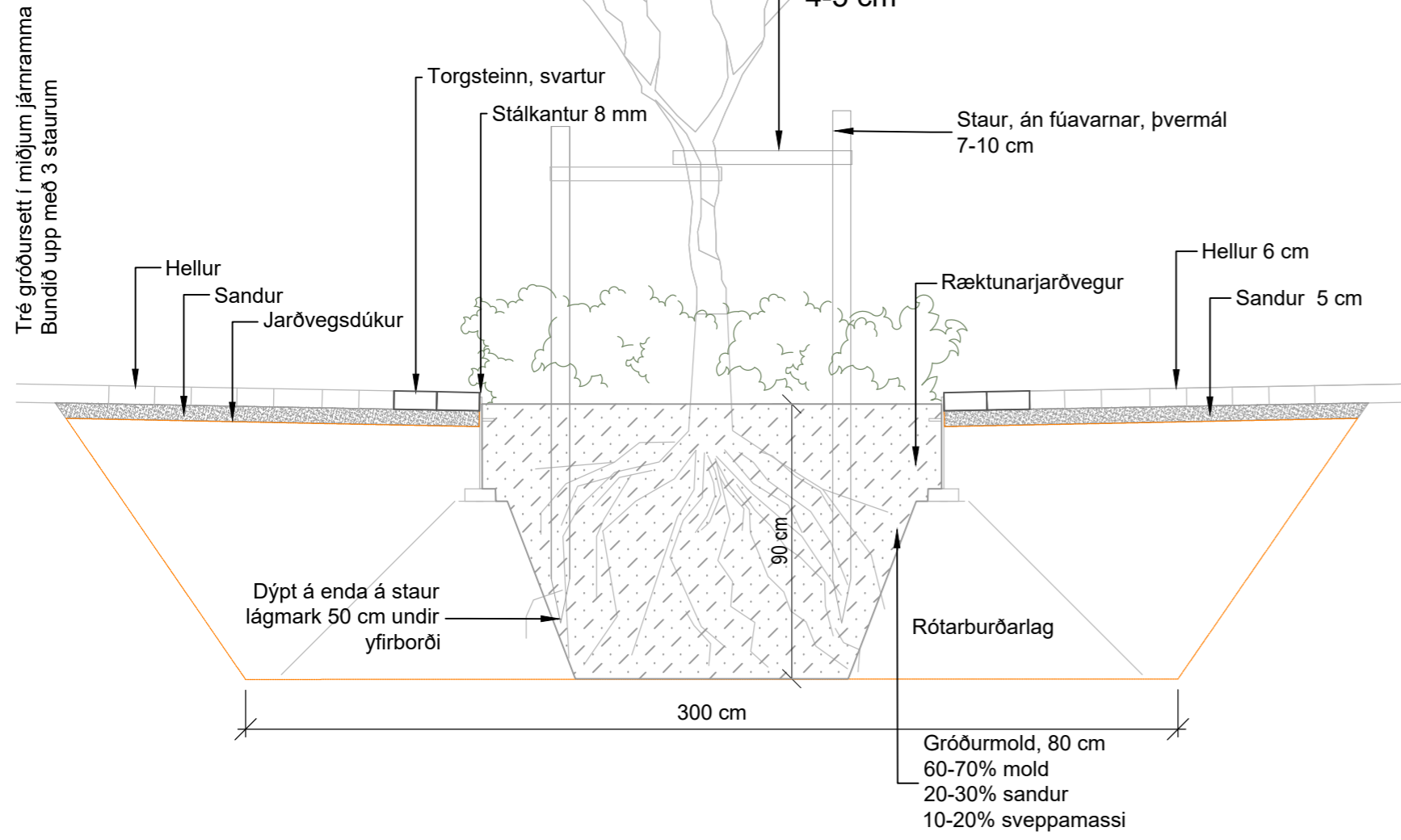

- SNIÐ - UPPBINDING TRÉ
- 1:20

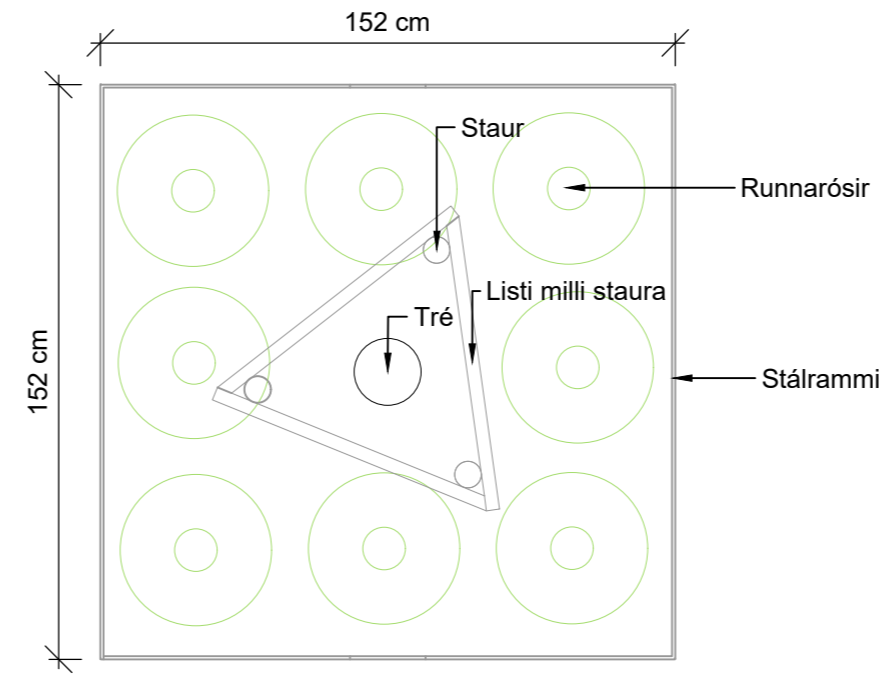

- GRUNNMYND - STÁLRAMMI OG UPPBINDING
- 1:20

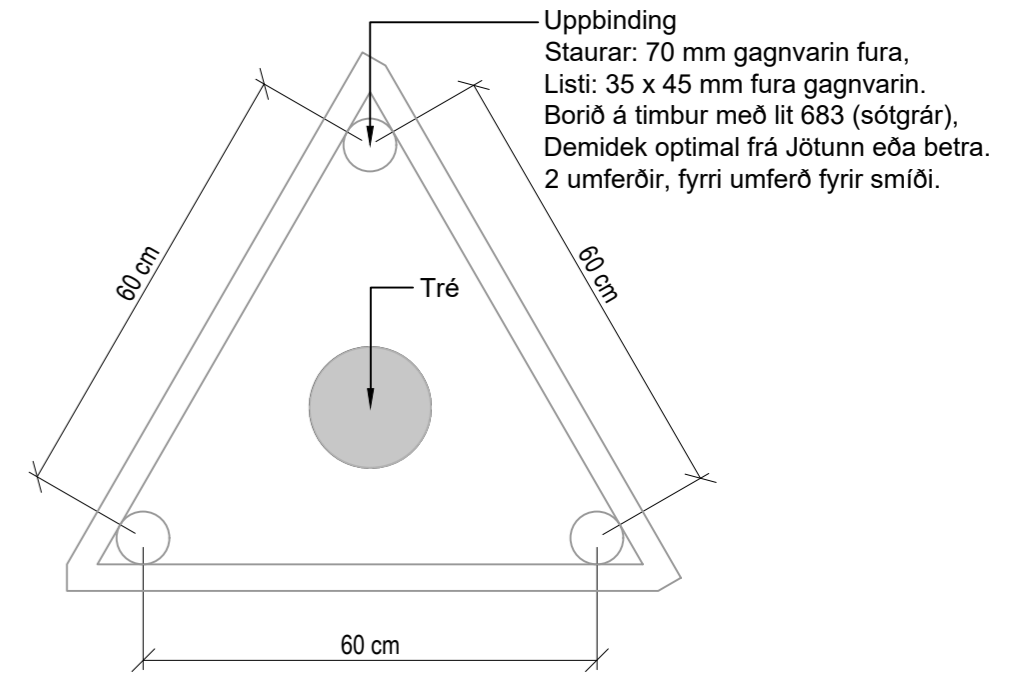

- UPPBINDING Í TRÉ
- 1:10

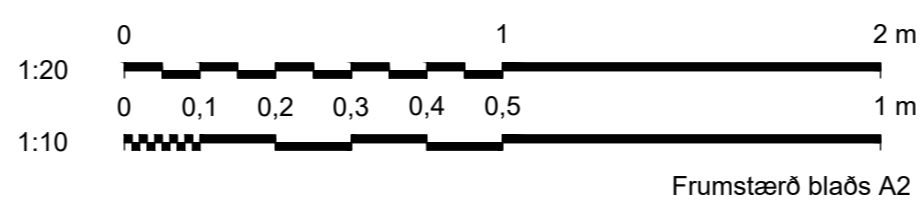

www.verkis.is - sími: 422 8000		Reykjavíkurborg Umhverfis- og skipulagssvið		Borgartún 12-14 105 Reykjavík Sími: 411 1111	
SAMPYKKT:					
GUFUNES 1. ÁFANGI GATNAGERÐ, YFIRBORDSFRÁGANGUR Sérteikningar og snið - gróður, frágangur					
A 2024-07-04 ÚTG DAGS VERKFANG	VERKTEIKNING SKÝRINGAR 18117	AKA HANN 003.C71.O47	ÞRS RÝNT A	GJ SAMP A	Mkv: 1:20/1:10 Dags: 2024-07-04
			Stærð: A2	Teikn. nr.: O47	Útg.: A